



MAD
USER
MANUAL



MAD

M230-BTN

MADE TO PLAY LOUD

WE PLAY LOUD!!

We know what you want. You want it LOUD, and that's exactly what we do, what we live for. Vibrations, gut-punches and straight up loud music - that's what makes us tick. We won't dress up in fancy words or claim to be something we're not. We are the NO BULLSH!T car audio brand!









Every single product with the GAS logo on it is born out of passion, the same that has driven us for two generations and that will keep us rolling up to your neighbourhood, winning and pushing the limits for many generations to come!

It's up to you to choose your own level of loud, and if you don't like what we do that's OK. You are welcome back when you've had your first true GAS experience. We don't exclude, we don't judge and we do not make up any excuses for who we are.

We are GAS and we are proud to be LOUD!

GAS

TABLE OF CONTENT

 SAFETY.....	3
 UNPACKING.....	4
 DIMENSIONS.....	4
 SPECIFICATIONS.....	5
 FUNCTIONS.....	7
Panel key function.....	7
Remote control.....	9
 HOW TO.....	10
Quick start.....	10
Audio setting.....	12
EQ settings.....	13
X-over setting.....	14
Understanding x-over.....	15
FLA setting.....	17
Understanding FLA.....	17
FM Tuner.....	18
Bluetooth.....	19
Display.....	20
Clock.....	21
 TROUBLESHOOTING.....	22
No power.....	22
Unwanted noise.....	22
Distortion.....	22
 WARRANTY & DISPOSAL.....	23
 THE GAS WORLD.....	24



SAFETY

PLAY LOUD & SAFE. Before installing your MAD head unit, make sure that you read through the manual thoroughly and follow the instructions. Save the manual for future usage and reference!

Make sure to pay attention to the instructions when you see this symbol: 

Make sure that your vehicle has a 12 VDC voltage negative ground system, that it can handle an increased power consumption, and that both the alternator and the power source are healthy and up to the task.

Do not install the head unit where it may be exposed to dirt, excessive damp or moisture. If the head unit is exposed it might result in electric failure, shock or damage to the product. Your head unit will produce heat so make sure it'll have sufficient air circulation. Servicing is required when the product has been damaged in any way and /or doesn't operate normally. Refer all services to qualified service personnel only.

Keep the cables inside the vehicle separate from sharp edges or components that may be affected or take damage. Follow the recommended cable sizes and always use high quality cables and accessories. Even if you're eager to put the head unit to use - take no shortcuts when installing the unit, make sure that all connectors are protected and secured.

Don't drill any holes without checking what lies beneath, and don't cut anything without making sure that no important components risk being damaged.

There's a first time for everything, if you need help - ask a friend or contact your local GAS AUDIO POWER dealer/installer.

We want you to experience your product's MAD sound, but we don't want you to injure yourself or others. Use common sense, respect high pressure levels and volume, and follow your local laws and regulations.



UNPACKING

We know you're excited to dive head first into installing your new head unit, but before you do: Make sure that the head unit and all the accessories are included in the packaging.

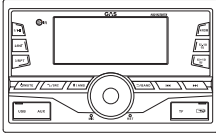

Head unit



Remote

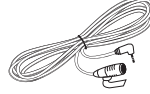

Microphone

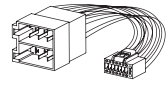

ISO connection
(1 pcs)



Manual

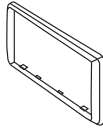

Trim panel

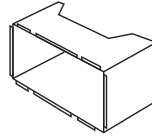

Mounting
sleeve



Removal keys
(2 pcs)

DIMENSIONS

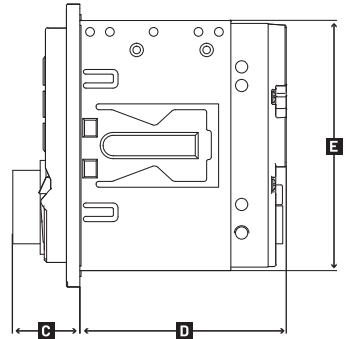
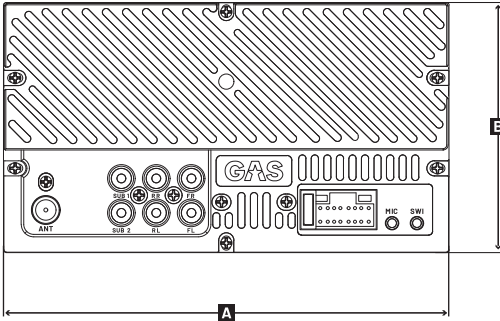

	A	B	C	D	E	
M230BTN	177.5	99.6	27.49	84	102.7	mm

SPECIFICATIONS

We take pride in our work! Listening, measuring and engineering are essential parts in our workshop. That's how we make sure to bring you an awesome product with NO BULLSH!T.

GENERAL

Power source	14.4V (11-16V)
Grounding	Negative type
Maximum current consumption	15A
Operational temp.	-10°C to +60°C
Weight (net)	0.9KG
LED backlighting	7 colors
Illuminated buttons	7 colors
2V Pre-outs 3 pair	Front, Rear, Sub
Steering wheel remote	Compatible
Remote control	Included
Power antenna lead	+12V to external amp. or electric antenna
Firmware updates	Via USB-port
Dimmer settings	Yes
Clock	Yes
Memory backup	Yes

AUDIO

MAX output power	4x50W
Full bandwidth power (at less than 10%THD)	4x25W
Speaker impedance	4- 8 Ohm
Pre-out level	2000 mV / 10kOhm load
Frequency response	20Hz-20KHz (±3dB)
Pre-out impedance	> 100 Ohm

USB

USB standard	USB1.1, USB 2.0
File system	FAT12/16/32
Maximum supply current	DC 5V=1.5A
Total harmonic distortion	0.01% (1kHz)
Signal to Noise ratio	85dB(1kHz)
Channel separation	80dB (1kHz)
MP3 decode	Compliant with MPEG1/2 Audio Layer3

SPECIFICATIONS

FM RADIO

Frequency range	87.5MHz-108MHz (50kHz step)
Usable sensitivity	10dB(S/N=30dB)
Quieting sensitivity	55dB (S/N=46dB)
S/N ratio (mono)	MNO 1MV 60dB
Stereo separation	40dB (1kHz)

AUX

Frequency response	20Hz - 20kHz (± 3dB)
Input MAX voltage	1000mV
Input impedance	30kOhm

BLUETOOTH

Version	BT 5.3
Bluetooth frequency range	2402GHz- 2480GHz
RF output power (E.I.R.P.)	4dBm (MAX), Power Class2
Maximum communication range	Line of sight, approx 10m
Profile	HFP1.7.1 (Hands free profile)
	A2DP
	AVRCP1.6.1
	Serial port profile

EQ/NETWORK SET

Equalizer 14-band	30Hz, 60Hz, 80Hz, 120Hz, 160Hz, 250Hz, 400Hz, 600Hz, 1.5KHz, 2.5KHz, 4KHz, 8KHz, 12KHz, 16KHz
Equalizer range	-18dB to +18dB (1dB steps)
FLA SET FINE LEVEL ADJUSTMENT	Position Front L, Front R, Center, Custom Front L/R REAR L/R SUB 0 to -38, 75dB (1.25dB steps)
SUB SET / SW FREQ	OFF, 30Hz, 60Hz, 80Hz, 100Hz, 120Hz, 150Hz, 180Hz, 200Hz, 250Hz, 300Hz
PHASE	Normal/Reverse
GAIN	0 to +5 (1dB steps)
SLOPE	6, 12, 18, 24 dB/Oct
F+R SET / HPF FREQ	THROUGH, 30Hz, 40Hz, 50Hz, 60Hz, 70Hz, 80Hz, 90Hz, 100Hz, 120Hz, 150Hz, 180Hz, 200Hz, 250Hz, 300Hz
GAIN	0 to +5 (1dB steps)
SLOPE	6, 12, 18, 24 dB/Oct

FUNCTIONS

The MAD head units are made to be LOUD and last for years to come. We want to help you and your vehicle to be as LOUD as possible. We've packed the head unit with a bunch of interesting features. We know you're itching to get your new sound system going, but make sure to read through these pages - so you can get the most out of your setup!

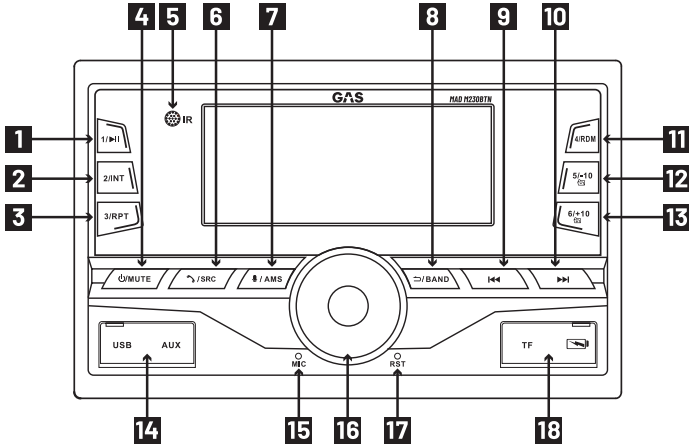

1	NUMBER BUTTONS (1-6)
2	
3	<i>Radio mode:</i> Stored radio stations.
11	<i>USB mode:</i>
12	1 Paus/Play
13	2 Int - SCAN ON / SCAN OFF
	3 Repeat - Track / Folder / OFF
	4 Random Play - ALL / OFF
	5 Go to previous folder
	6 Go to next folder

4	(ON/OFF) / MUTE
	<i>Shutdown status:</i> Short press to open the device
	<i>Running status:</i> Short press to mute/unmute
	<i>Power on status:</i> Long press to turn off the device

5	INFRARED RECEIVER
	Infrared eye for remote control.

6	PHONE / SRC
	<i>BT mode:</i> Calling the last dialed number on your mobile phone. Answer incoming Call.
	<i>In operation:</i> Change of source FM Radio, USB(When connection), Aux in, Bluetooth.

7	VOICE / AMS
	Short press: Turn on voice function
	Long press: Search for radio channels

FUNCTIONS

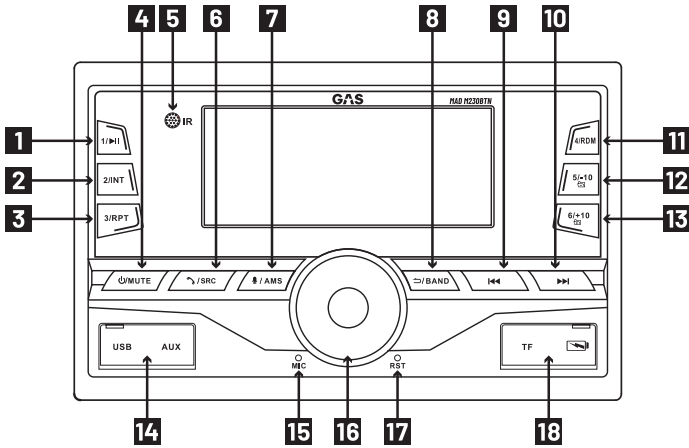

8	BACK / BAND
	<p><i>MENU mode:</i> Back. Return to the previous menu</p> <p><i>Radio mode:</i> Changes to next 6 stored stations.</p> <p><i>USB mode:</i> Name of the File, Folder, Title, Album, Artist.</p>

9 10	PREVIOUS / NEXT
	<p><i>Radio mode:</i> Start/Stop search radio station.</p> <p><i>BT mode:</i></p> <p>>> One press: Skip to next track</p> <p> << One short press: Jump to the beginning of the track (if the track has played +10 sec, or prev. track).</p> <p> << Press twice: Go to prev. track.</p>

14	USB & AUX PORT
	<p>Playback from USB devices and USB charging (5V 1A)</p> <p>3.5mm external audio input</p>

15	BUILT-IN MICROPHONE
	<p>Mic. for answering phone calls.</p>

16	VOLUME KNOB
	<p>Rotate to adjust volume. Navigate up/down in the menus</p> <p>MENU mode: Press to select.</p>

17	RESET BUTTON
	<p>Restore to default factory settings of the device. WARNING! All your personal settings will be lost.</p>

18	TF & TYPE-C PORT
	<p>Playback from TF card</p> <p>Type-C 1.5A Charging</p>

FUNCTIONS

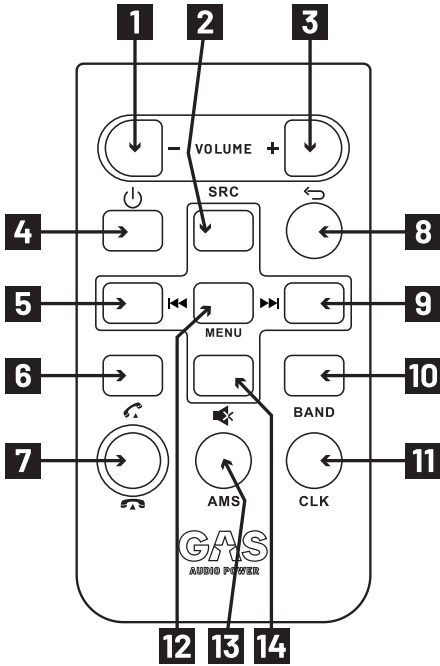

1 **VOLUME INCREASE / DECREASE**
3 Volume Increase / Decrease + / -

2 **SRC**
 Switch between sources.

4 **POWER OFF**
 Press the machine to shut down

5 **PREVIOUS / NEXT TRACK**
9 Go to previous / next track.

6 **ANSWER CALL**
 Incoming phone call: Answer

7 **REJECT CALL**
 Incoming phone call: Reject

8 **RETURN**
 Press to return

10 **BAND**
 Browse stored radio channel.

11 **CLK**
 Short press: Shows the clock.
 Long press: Turn off the display.

12 **MENU**
 Press to open menu

13 **AMS**
 Automatic station search

14 **MUTE/UNMUTE**
 Press mute button
 Press to unmute in mute state

How to replace the battery in the remote

HOW TO

A well-built sound system will set you aside from the rest and elevate your vehicle! It's important that you carefully read the instructions on the following pages. This is to make sure that you use the head unit correctly, so your system is as LOUD as possible!

QUICK START

1) Press  to start the head unit.

2) Set Clock and Date

- Press Volume knob. Turn until the [CLOCK] menu is shown.
- Press Volume knob to enter the menu.
- Press volume knob to enter [CLK FRMT]
- Turn Volume knob to set 12H or 24H. Confirm by press Volume knob.
- Turn Volume knob for [CLK ADJ]
- Press Volume knob to enter. Set Hour. By rotating Volume knob. Confirm by press Volume knob. Repeat for Minutes.

- Turn Volume knob for [DATE FRMT]
- Press Volume knob to enter
- Turn Volume knob to set DD-MM-YY or MM-DD-YY. Confirm by press Volume knob.
- Turn Volume knob to [DATE SET]
- Press Volume knob to enter
- Turn Volume knob to set Day Confirm by press Volume knob. Repeat for Month and year.
- Press Back /BND / Phone button to go back to menu.

3) Turn of DEMO-mode

- Press Volume knob. Turn until the [DEMO MODE] menu is shown.
- Press Volume knob to enter the menu.
- Turn Volume knob for [OFF / ON] Choose "OFF" Confirm by press Volume knob.
- Press Back /BND / Phone button to go back to menu.

4) Bluetooth Pairing

- Press SCR until [BT MODE] shows in the display
- Open Bluetooth settings on your mobile device.
- Find "MAD M230BTN"
- Connect your mobile device to the head unit.

5) Remote Control

- Remove the insulation sheet between the battery and the power connectors.

HOW TO

Turn ON/OFF head unit via vehicle ignition

If the car audio system is connected with the vehicle ignition, turning off the ignition key also switches off the device. Switching on the ignition will turn on the device.

Memory function

The head unit has a memory function to store radio channels. The radio channels are stored when the power is turned off and will be shown again once the power is turned on.

Volume adjustment

The volume on the head unit can be adjusted in steps from 0 (min) to 63 (max). Simply adjust the volume either by turning the volume knob on the unit or use the included remote control.

Storing radio station

Select the desired preset with the BAND-button. Set the desired station by pressing one of the preset buttons [1]-[6] for approximately 3 seconds to store the current station at the button. Up to 6 stations can be stored in each bank (there are 3 banks), so up to 18 stations can be stored in total. Press the BAND-button to change memory bank, press the preset buttons [1]-[6] to choose the stored station.

USB/TF media playback

The car audio system can be used to play MP3 files as well as WMA, ACC, WAV & FLAC files on USB drive And TF card. Turn of the car audio system before removing the USB/TF. The source USB/TF is automatically chosen when it is plugged into the head unit.

Preset button [1] is for Play/Pause and preset button [2] plays the first 10 sec of the chosen track. Preset button [3] gives you repeat options (RPT ONE, RPT DIR, RPT ALL) and preset button [11] gives you the option to random the playing order of the tracks. Use the preset buttons [12-13] on the head unit to browse through folders.



HOW TO

AUDIO SETTING

This menu setting includes options to adjust the performance of the sound system and the audio. Turn the volume knob to browse the menu and select the AUDIO option. There are ten different settings you can adjust. When you have selected a setting, turn the volume knob to change the value. Push the volume knob to confirm the change. Press the Back / BND / Phone button on the unit to go back to previous menu.

MENU SETTING	FUNCTION	VALUES
[SW LEVEL]	Subwoofer Level.	SVOL [0]-[+15]
[PRESET EQ]	Select equalizer curve from 5 different EQ presets. (Create customs in PRO EQ)	USER/NATURAL/POP/ ROCK/TECHNO
[FADER]	Adjust the relative level between front and back speakers.	[R31-R1]-[0]-[F1-F31]
[BALANCE]	Adjust the relative level between left and right speakers.	[L31-L1]-[0]-[R1-R31]
[X-BASS]	Virtual Bass	FREQ-OFF/60HZ/80HZ/ 120HZ/160HZ/200HZ/300HZ
		GAIN[0]-[10]
[LOUD]	Equal Loudness	OFF/ON
[DRC]	Dynamic Range Compression	OFF/ON
[BASS]	Bass adjustment	[-7]-[+7]
[TREBLE]	Treble adjustment	[-7]-[+7]
[AUDIO RESET]	Audio Reset	NO/YES

HOW TO

EQ SETTING

In the [PRESET EQ] menu you can choose between natural, pop, rock or techno EQ presets or you can create your own sound in the [USER] settings, Use the volume knob to browse the menu and select the EQ SETTING option, by pushing the volume knob. When you have selected a setting, turn the volume knob to change the value. Push the volume knob to confirm the change. Press the Back/BND/Phone button on the unit to go back to previous menu.

USER PRESET EQ

Create a custom equalizer curve in the [PRESET EQ][USER] setting.

Equalizer bands are selected in the following order:

**30Hz - 60Hz - 80Hz - 120Hz - 160Hz - 250Hz - 400Hz - 600Hz - 1.5KHz - 2.5KHz
- 4KHz - 8KHz - 12KHz - 16KHz**

By pressing the Volume knob while standing on a frequency, you access the [LEVEL] menu of the band. Each band can be individually adjusted in level by [-18] to [+18] dB.



HOW TO

X/OVER SETTING

This menu includes options to adjust the main settings of the sound system. Use the volume knob to browse the menu and select the XOVER option. Here you can set the low pass crossover for your subwoofers and high pass crossovers for your front and rear door speakers. When you have selected a setting, push the volume knob to enter the menu. Turn the volume knob to change the value. Push to confirm the adjustment. Press the Search/Back button on the unit to go back to previous menu.

MENU SETTING	FUNCTION	VALUES
[SUB SET]	[SW FREQ]	SW OFF :30HZ/60HZ/80HZ/ 100HZ/120HZ/150HZ/180HZ/ 200HZ/250HZ/300HZ
		SW PHASE: NORMAL /REVERSE
		SW GAIN:[0]-[5]
		SW SLOPE: 6dB/12dB/18dB/24dB
[F+R SET]	[HPF FREQ]	THROUGH 30HZ/40HZ/50HZ/ 60HZ/70HZ/80HZ/90HZ/ 100HZ/120HZ/150HZ/180HZ/ 200HZ/250HZ/300HZ
		HPF GAIN:[0]-[5]
		HPF SOLPE: 6dB/12dB/18dB/24dB



HOW TO

UNDERSTANDING X-OVER

Adjusting crossover settings is the key when it comes to sound optimization. The crossover function gives you a great variety of options to customize your own settings, just for your sound system. Use the Notes page in the back of the manual to write down your crossover settings for future reference.

Illustrated picture

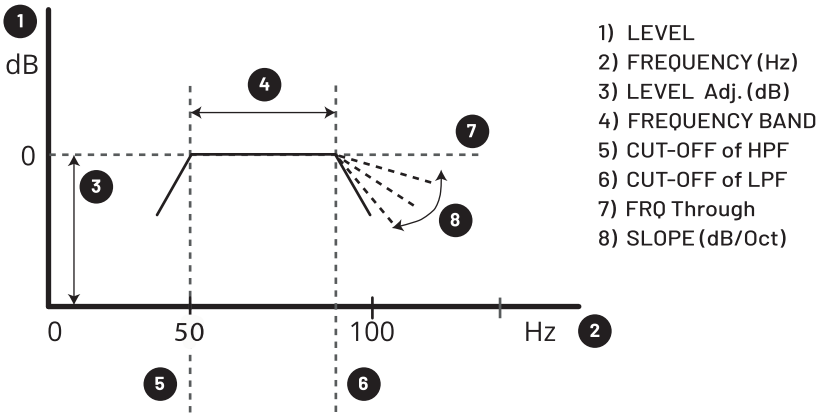

Using Cut-off of the HPF (High-Pass Filter) or LPF (Low-Pass Filter) gives you the possibility to adjust the frequency range for each line out.

- **HPF - High Pass filter** lets the high frequencies pass and cuts off the lower frequencies.
- **LPF - Low Pass filter** lets the low frequencies pass and cuts off the higher frequencies.
- **Pass through** - No filter is used
- **Level:** Adjusts the different levels between the outputs.
- **Slope:** Lets you adjust the frequency range for each output. The slope shows how many decibels that the signal is dropping when the frequency is one octave lower (or higher). How many dB/oct. the signal is dropping for each unit. Adjustable between 6, 12, 18 & 24 dB/oct.

HOW TO

UNDERSTANDING X-OVER

• **Phase:** By changing phase (normal, reverse) you can adjust the signal between 0 and 180 degrees. Reversing the phase can improve the sound around the crossover frequency.

• **Q-Value:** A low Q value will give you a wide band and affect more frequencies. A high Q value will give you a more narrow band and is great to cut or boost more specific frequencies. For Low/High Pass filters and Shelving filters, a high Q value will add a more defined "bump" at the frequency position. This results in a small boost or a more resonant sound with extreme values.

Calculate the Q-value:

$$Q = Fc / \text{Bandwidth (-3dB point)}$$

Fc = Center frequency

Bandwidth = From start to stop frequency

GAIN determines the level of the peak (dip)

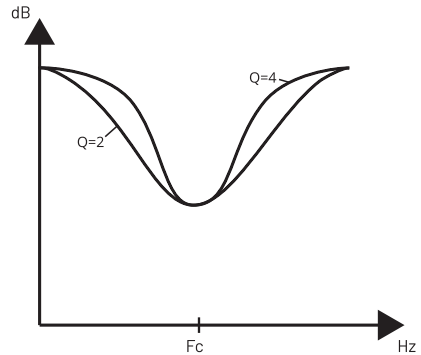

HOW TO

UNDERSTANDING FLA

Fine Level Adjustment sets the level of each speaker to create a more correct audio presentation, since the speakers are installed at different distances from the sweet spot.

By lowering the level of the closest located speaker you make the sound stage more accurate in front of you.

How to set Fine Level Adjustment

1. In the FLA CUSTOM menu Front Left, Front Right, Rear Left, Rear Right and Subwoofer can be Fine Level Adjusted.
2. There are 3 Presets for Front Left, Front Right and Center
3. When adjusting the CUSTOM setting. Start listen to one of your favourite music tracks and listen to the voice. Where is the voice located in the soundstage on the dashboard in front of you? Probably to the left of the steering wheel.
4. Adjust the Front Left speaker from 0db to -1.25dB to -2.5dB and so on. When the voice has moved from the left in the soundstage to a more center location you have found the right position.

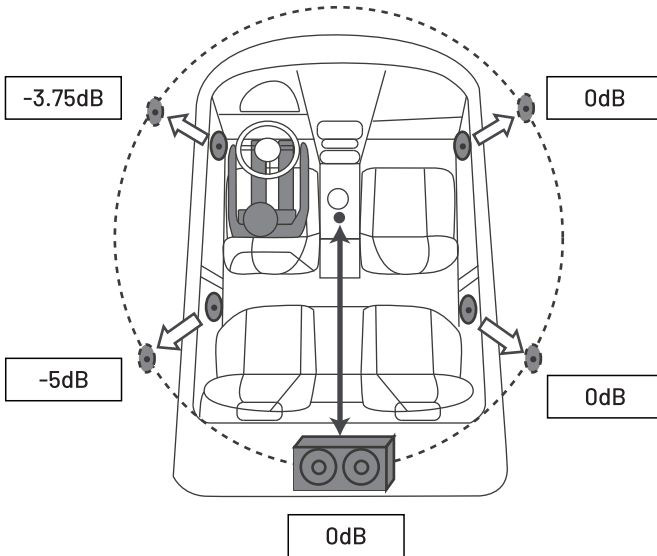

HOW TO

FLA SETTING		
POSITION	CUSTOM \FRONT R \FRONT L \CENTER	
LEVEL	-1.25dB steps	
DISTANCE	FRONT LEFT	[0dB] - [-38.75dB]
	FRONT RIGHT	[0dB] - [-38.75dB]
	REAR LEFT	[0dB] - [-38.75dB]
	REAR RIGHT	[0dB] - [-38.75dB]
	SUBWOOFER	[0dB] - [-38.75dB]
FLA RESET	Resets all FLA settings	
	NO / YES	

FM TUNER

This menu setting includes options to adjust the settings of the head unit's FM radio. Use the volume knob to browse the menu and select the TUNER option. When you have selected a setting, turn the volume knob to change the value. Press the Search/Back button on the unit to go back to the menu.

MENU SETTING	FUNCTION	VALUES
[REGIONAL]	Radio area selection	EUROPE/USA/ASIA/ RUSSIA
[MONO/STEREO]	Switch stereo or mono	STEREO OR MONO
[DX/LOCAL]	Far/near broadcast search	LONG/SHORT RANGE SWITCH
[RDS]	(Radio Data System) signal with additional functions, like displaying the name of the radio station.	OFF, ON
[TA]	Traffic Announcement	OFF, ON
[AF]	Alternative frequency	OFF, ON
[EON]	Enhanced other Networks	OFF, ON
[REG]	Regional Radio Programmes	OFF, ON
[PTY]	Program Type	OFF, ON



HOW TO

BLUETOOTH FUNCTIONS

The Bluetooth® function allows pairing cell phones & BT equipped media playback devices with the car audio system. When you connect a cell phone with the car audio system, you can make phone calls with the built-in hands free function. You can access the last dialed number on your mobile device.

If the connected Bluetooth® device supports functions like A2DP and AVRCP, you can play music via the car audio system and control playback. During a call, music playback is interrupted and resumes again after the call.

If a cell phone is registered via Bluetooth® and a call is received during playback, the source playback is interrupted and the call menu is displayed. To get the best quality in the conversation, it's recommended to use the external microphone.

Connect the microphone to the head unit. To capture your voice during handsfree calling, you need to install the microphone. The cable is 2.95m long.

Mount the microphone as close to the driving position as possible. The cord must be safely installed.

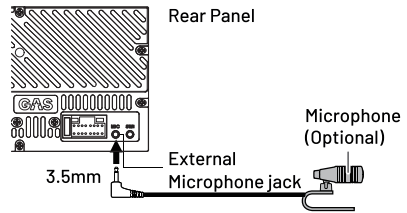

CONNECTING BLUETOOTH DEVICE

Press the SRC button until you get to the [BLUETOOTH] option. Find "MAD M230BTN" in the list of Bluetooth devices on your mobile phone and select it to connect.

HANDS-FREE PHONE CALLS

GAS MAD M230BTN head unit handles hands-free phone calls with the external or internal microphone. When you receive an incoming phone call, you simply answer by pressing the ["PHONE"/SRC] button on the head unit or the ["ANSWER CALL"] button on the remote control. To end the phone call you press the ["PHONE"/SRC] button on the head unit or the ["REJECT CALL"] button on the remote control.

If you wish to make a phone call directly through the MAD M230BTN head unit, press the ["PHONE"/SRC] button on the unit to call the latest phone number in your call-log.

HOW TO

DISPLAY

This menu setting includes options to adjust the head unit's display and buttons LED lightning colors. Use the volume knob to browse the menu and select the DISPLAY option. There are seven different colors you can adjust. When you have selected a setting, turn the volume knob to change the value. Press the Search/Back button on the unit to go back in the menu.

MENU SETTING: DISPLAY		
DISPLAY OPTION	FUNCTION	VALUES
[MODE SET]	C-MODE1 / C-MODE2/ C-MODE3	Color select Running RGB colors RGB shift
[COLOR SET]	Choose color on the display text and buttons.	AUTO/RED/GREEN/BLUE/ YELLOW/CYAN/PURPLE/ WHITE
[SPECTRUM]	Moving graphics on display.	OFF, ON
[ID3 TAG]	Only works on stored music such as MP3,FLAC, etc.	OFF, ON



HOW TO

MENU SETTING: CLOCK		
DISPLAY OPTION	FUNCTION	VALUES
[CLOCK FORMAT]	Setting of clock format.	12H, 24H
[CLOCK ADJUST]	Change time on the display.	00:00
[DATE FORMAT]	Setting of date format.	DD/MM/YY MM/DD/YY
[DATE SET]	Change date on the display.	01/01/22

MENU SETTING	FUNCTION	VALUES
[DEMO MODE]	Use demo mode of the unit.	OFF, ON
[ANIMATION]	Speed settings of display animations.	PER 15 SEC, PER 30 SEC PER 1, 2, 4 MIN, OFF

TROUBLESHOOTING

NO POWER

Check the head unit to make sure it isn't damaged. If your system doesn't get any power, the most common issue is either in the wiring or the fuse. Use a multimeter to measure the head unit voltages, both yellow and red cable (+12-16V)

Check that all speaker cables are connected to your sound system. If you are using a car specific cable harness, make sure it is for your car model. Most modern cars have some kind of CAN-Bus system to start the OEM head unit, for these cars a special CAN-Bus harness is needed. Make sure that the RCA cables are properly connected if external amplifier is used and that you have 12V remote on the external amplifier.

UNWANTED NOISE

Start by looking over the speakers in the sound system so there is no damage or connection issue with the wiring. Make sure that your signal cables or speaker cables aren't too close to the power cables. If the noise changes with the accelerator, it is most certain a ground loop issue. Make sure that the grounding point is good, especially if an external amplifier is used.

When all of the above has been tested/looked over, and the unwanted noise does not vanish, consult your local GAS dealer.

DISTORTION

Start by looking over the installation and all cables in the sound system so there's no damage or connection issue with the wiring. Check the speaker cables to make sure that the polarity isn't reversed on one channel. If an external amplifier is used, make sure that the gain/level is set according to the amplifier's instructions. If your amplifier has a boost function, lower its effect or turn it off.

WARRANTY & DISPOSAL

This product is covered by warranty, depending on the conditions in the country where it's sold. If the subwoofer is returned for service, please include the original dated receipt (or a copy) with the product. Make sure that the subwoofer is packaged properly and secured, preferably in its original packaging.



The crossed-out wheeie bin symbol means that the product, literature and packaging included must be taken to separate collection at the end of their working life. Don't dispose of these products as unsorted municipal waste: take them for recycling. For info on your nearest recycling point, check with your local waste authority.



This product has been granted with the CE certification mark to show that the product follows the health, safety, and environmental protection standards for products sold within the European Economic Area (EEA).



GAS Audio Power products comply with the relevant provisions of the RoHS Directive for the European Union. In common with all Electrical and Electronic Equipment (EEE) the product shouldn't be disposed of as household waste. Alternative arrangements may apply in other jurisdictions.



GAS Audio Power is a global partner of the European Mobile Media Association, an organization that focus on promoting the custom made mobile media installations to consumers.



THE GAS WORLD

You've entered the world of GAS. We aim to please, and we've made sure to have products made for you. No matter what stage of the LOUD-addiction you might find yourself in, there is a GAS product to fill your need.

MAD

Just starting out? The MAD series is made to play LOUD and to be the express lane to a no bullsh!t sound system that will make sure everyone can hear you coming!

MAX

The MAX series holds products made to deserve the center stage. Powerful, heavy duty and designed to be noticed. We made NO COMPROMISES because we know that you wouldn't accept it.

CMP

The CMP series has been developed for the crucial seconds when the dB-counter starts to tick. All CMP products have hand-picked, high quality, COMPETITION GRADE components and they are specially designed to withstand an awesome amount of power.



THANKS FOR JOINING GAS AUDIO POWER!



GAS
AUDIO POWER

GAS AUDIO POWER and SHAKY are registered trademarks by Winn Scandinavia AB and is protected by relevant laws and jurisdictions such as Copyright and Trademark laws.

Winn Scandinavia AB | Idrottsvägen 37, 70232 Örebro, Sweden | www.winnscandinavia.com

Winn Scandinavia AB reserves for possible typos, factual or numeric errors that may have been printed on any products, package designs, user manuals and/or other included accessories.

Winn Scandinavia AB can't guarantee flawless function/performance of our products together with third-party accessories and products like USB data carriers, MicroSD cards, cables, etc.



GAS
AUDIO POWER