

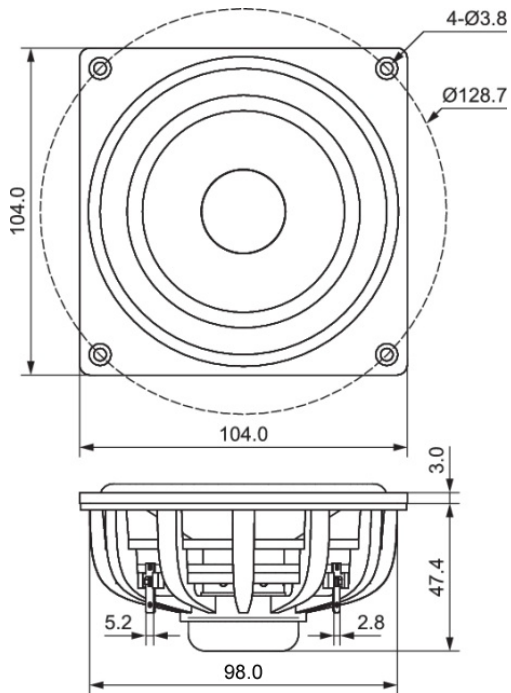

DMA105-8 4" Dual Magnet Aluminum Cone Full-Range Driver 8 Ohm



PARAMETERS

Impedance	8 ohms
Re	7.5 ohms
Le	0.6 mH @ 1 kHz
Fs	72.0 Hz
Qms	2.64
Qes	0.83
Qts	0.63
Mms	4.9 g
Cms	1.0 mm/N
Sd	54.1 cm ²
Vd	13.5 cm ³
BL	4.5 Tm
Vas	0.15 ft ³
Xmax	2.5 mm
VC Diameter	1"
SPL	84.8 dB @ 2.83V/1m
RMS Power Handling	35 watts
Usable Frequency Range (Hz)	70-20,000 Hz

FEATURES

- Excellent high frequency response for true full-range applications
- Dual neodymium motor to create a symmetrical magnetic field for superb control
- Large copper cap lowers distortion while improving high frequency response
- Vented aluminum voice coil former with exceptional heat dissipation for high power handling
- Exclusive 12-spoke open frame design provides extensive venting and minimal reflection
- DIY friendly, oversized mounting flange makes installation simple
- Matching tunable passive radiators also available!

IMPEDANCE/PHASE

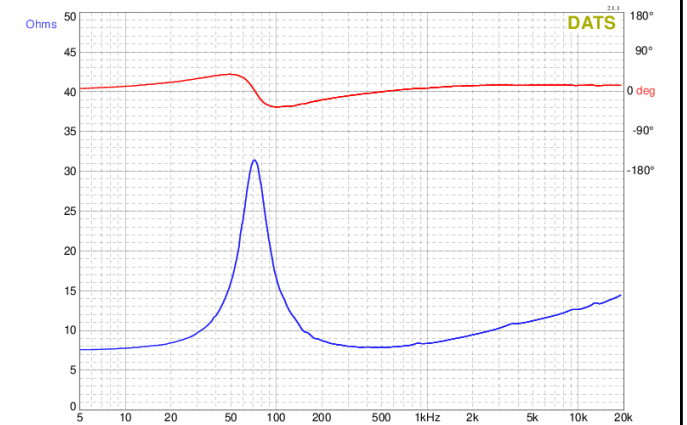

FREQUENCY RESPONSE

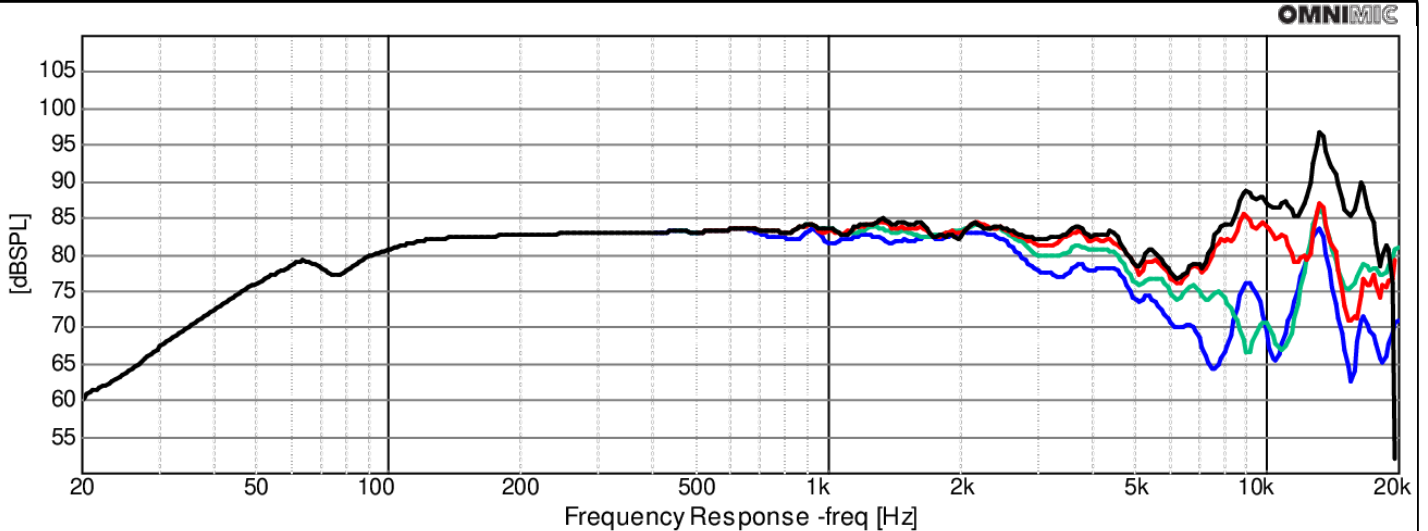

OmniMic

Note: 1/24th octave smoothing - nearfield response included in graph below 450 Hz.

Black = 0°
Red = 15°
Green = 30°
Blue = 45°