

ONKYO®

INSTRUCTION MANUAL
使用手冊



R-MX100

DIGITAL SIGNAL PROCESSOR

音訊處理器



Made in China

BEFORE USING R-MX100

Thank you very much for purchasing an Onkyo audio processor. Please read this manual carefully before use. Follow the instructions and instructions of this user manual to operate, and you will get the best sound effects and listening enjoyment through the newly purchased audio processor. Please keep this manual in a safe place for future reference.

- In order to prevent electrical short-circuits, do not place the device in rain or damp places.
- Be careful not to splash water or other liquids into the device. If water splashes into the device, the device may be damaged
- If water or other liquids enter the equipment, the power supply should be cut off immediately, and professional maintenance personnel should check and repair it to avoid accidents.
- If the equipment fails, please do not open the cover, please ask a professional to open and repair it.
- Before connecting this device, be sure to turn off your power. If you connect with the power on, the system may be damaged.
- Please place the device on a firm level surface. If it is placed on an inclined surface or placed unsteadily, not only will there be a danger of the device falling, but also its effect will be reduced.

TECHNICAL SHEET

Input Signal Type	2 low-level inputs, built-in Bluetooth, USB music playback, Coaxial/Optical digital input, external wiring controland (Optional)
Output Type	10CH low-level, 8CH High-level,
Output Gain	Gain Range: Mute, -59dB~0dB
Output Signal EQ	31 band EQ for every channel. <ul style="list-style-type: none">• Frequency Range: 20Hz~40KHz, Resolution 1Hz• Q value(Slope): 0,404~28,852• Gain: -12,0dB ~ +12,0dB, 0,1dB Resolution
Output Signal Crossover	Each channel is equipped with multi-order high and low pass independent filters. <ul style="list-style-type: none">• Filter type: Butterworth, Linkwitz-Riley, Bessel• Filter Crossover Point: 20Hz~40KHz, Resolution 1Hz• Filter slope setting: Off, 6dB/Oct to 48dB/Oct
Output Phase and Time Alignment	Adjust phase and time alignment for every output channel: In Phase 0° or Out Phase 180°; Time Alignment: 0,000 to 20 ms, 0 to 692 cm, 0" to 273".
Presets	The machine can save 6 preset music scenes.

SPECIFICATIONS

Dynamic Range (RCA Input):	≥100dB
S/N (RCA Input):	≥100dB
Total Harmonic Distortion:	≤0.05%
Frequency Response:	20Hz~40KHz
Input Impedance:	Low level Input: 20KΩ ; High level Input: 51Ω
Output Impedance:	Low level: 51Ω
RMS Power :	40W×8
MAX Power:	80W×8
Signal Input (MAX.):	RCA Input: 5.5Vpp ; High Level: 28Vpp
Signal Output (MAX.):	RCA Output: 5.5Vpp
Working Temperature:	-20℃~70℃
Power:	DC 9V~16V
REM Input:	High Level Input Signal: (H1+/H1-)- ACC start optional
REM Output:	+12V Startup Voltage Output (0.2A)
Standby Power:	≤0.1W
Net Weight:	Approx.1.3Kg
Unit Dimension:	187(L) ×175(W) ×43(H) mm
Accessories:	1× R-MX100 1× 1.5m USB2.0 Cable 1× 20cm Speaker Cable 1× 20cm Power&High Cable 1× Instruction Manual 4× Mounting Brackets 4× Installation Screws (PA4×20) 4× Installation Screws (PM3×6) 2× Magic Tape (85×55mm)

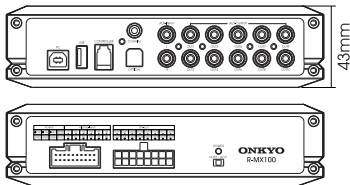
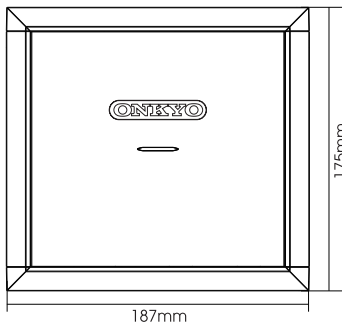

PANEL CONTROLS AND FEATURES

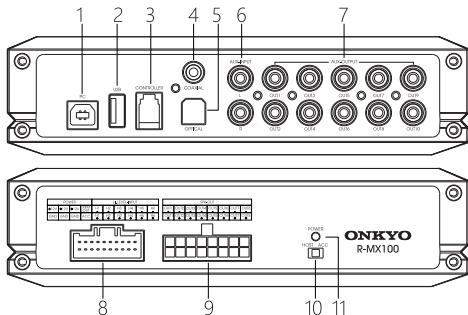

- 1. USB2.0 interface:** Connect to the computer tuning software, without driver installation.
- 2. USB flash drive port:** You can insert the USB flash drive and play the music of the USB flash drive.
- 3. Wire controller interface:** data call and total volume adjustment can be made through wire controller.
- 4. Coaxial input port:** Connect the car CD or DVD coaxial line, switch the mechanical sound source to digital, can play the same
- 5. Optical fiber input port:** Connect the car CD or DVD coaxial line, switch the mechanical sound source to digital, can play optical fiber digital signal.
- 6. Low level input interface:** USB flash drive can be inserted to play USB flash drive music.
- 7. Low level output interface:** up to 10 channels can be connected to low level output.
- 8. High level input and power interface**

POWER				Hi.LEVEL-INPUT					
+12V	+12V	+12V	REM OUT	- H1	- H2	- H3	- H4	- H5	- H6
GND	GND	GND	ACC	+ H1	+ H2	+ H3	+ H4	+ H5	+ H6

- 9. High level output interface**

SPK-OUT							
- OUT1	- OUT2	- OUT3	- OUT4	- OUT5	- OUT6	- OUT7	- OUT8
+ OUT1	+ OUT2	+ OUT3	+ OUT4	+ OUT5	+ OUT6	+ OUT7	+ OUT8

- 10. Machine start mode switch:** When the switch is switched to the "ACC" end, the ACC starts the machine, when it is switched to the "HOST" end, the high level H1+/H1- input signal starts the machine.
- 11. Power indicator**

PC SOFTWARE INTRODUCTION

Computer Configuration Requirements: Screen resolution higher than 1280 x 768, otherwise the software UI is incomplete, only suitable for windows operation system laptop, desktop and tablets,

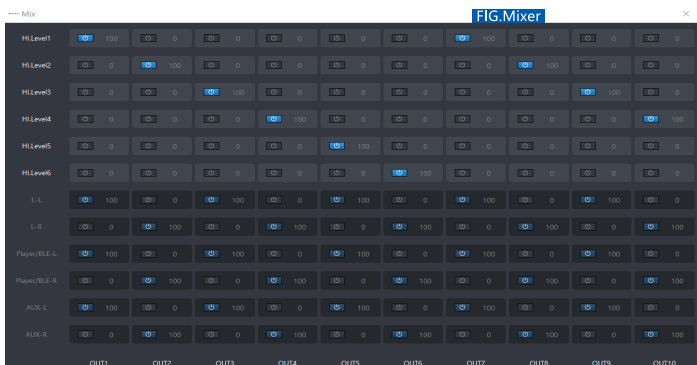
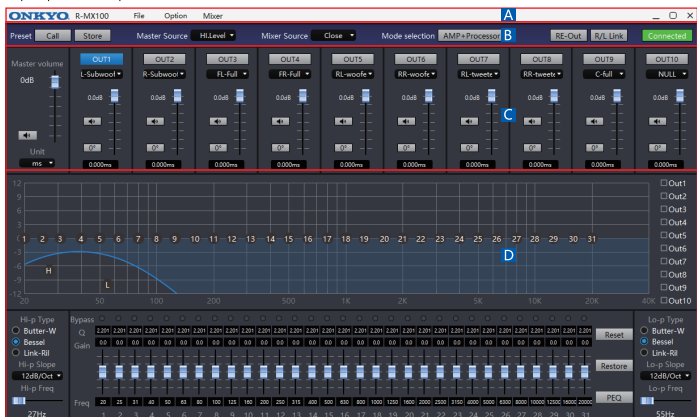

A. MENU EDITING AREA

Main functions: files, options and mixing settings.

- Click "File" to load as a computer scene file, save as a computer scene file, load as a whole machine file and save as a whole machine file.
- Click "Options" to switch between Chinese and English interfaces, enter advanced items to set the main audio source attenuation ratio and noise gate switch, firmware update, restore factory settings and view the version number and other information.
- Click "Mixer" to enter the mixing interface. (as FIG.Mixer)

B. FUNCTION EDITING AREA

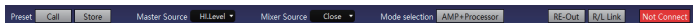

Main functions: recall or storage of preset sound effect files, main sound source and mixed sound source selection, mode selection, reset output type, output joint tuning and software connection.

- Click "Recall" or "Store" to recall or store 6 groups of preset sound effect data.
- Click the "Main Audio Source" drop-down box to select the input audio source. There are high-level, low-level, player and Bluetooth options.
- Click the drop-down box of "Mixed Audio Source" to select the mixed audio source. There are high-level, low-level, Bluetooth and off options.
- Click "Amplifier + Processor Mode" to switch to "Processor Mode".
- Click "Reset Output" to clear the current channel type or restore the factory default channel value.
- Click "Output joint debugging" to select the joint debugging synchronization mode, copy from left to right or copy from right to left.
- Click "Not Connected" to connect to the software, and click "Connect" to disconnect the software.

Note: You need to use a USB2.0 cable to connect the computer and the machine to operate!

C. TOTAL VOLUME AND OUTPUT CONFIGURATION EDITING AREA

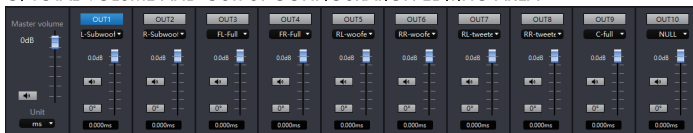

The main function:

Master volume adjustment and output channel configuration, volume adjustment, mute, forward and reverse switching and delay settings.

- Main volume: Adjustable range: Off, -59dB-6dB, click on the speaker to mute the main volume.
- Channel type: Click the channel type drop-down box to configure the output channel type.
- Channel volume: adjustable range: off, -59.9dB-0.0dB, click on the speaker to mute the channel.

- Phase: Click "Normal Phase" to switch to "Reverse Phase".
- Delay: Delay units are available in milliseconds, centimeters and inches. Adjustable range: 0,000 to 20 ms, 0 to 692 cm, 0" to 273".

D. EQ AND FILTER EDITING AREA

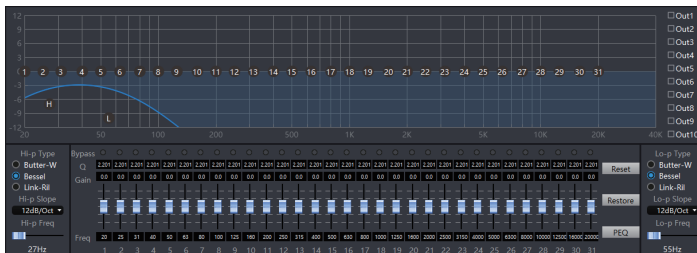

Main functions: channel high and low pass distribution settings, EQ settings and equalizer settings of the current output channel.

- Selection of high and low pass types: Butterworth, Bessel and Ninke-Sharp are available.
- High and low pass slope selection: off, 6dB/Oct, 12dB/Oct, 18dB/Oct, 24dB/Oct, 30dB/Oct, 36dB/Oct, 42dB/Oct and 48dB/Oct are optional.
- The range of high and low pass frequency can be set: 20Hz~40KHz.
- EQ curve setting: There are 31 segments of EQ can be set, you can drag the corresponding EQ segment to set the frequency, Q value and gain.
- EQ editing: gain, Q value and frequency can be set, Adjustable gain range: -12dB~+12dB; Adjustable range of Q value: 0,404~28,852; Frequency range: 20Hz~40KHz.
- Click "Reset" to restore the parameters of the 31-band equalizer to the original factory pass-through mode (the frequency, Q value and gain of the equalizer are all restored to the initial values.)
- When there is EQ curve adjustment, click "Straight" to restore the gain of all curves to 0,0, and click "Restore" to restore the last adjustment data.
- Click "parametric" equalization to switch to the "graphic" equalization interface, the gain, Q value and frequency can be set under the parametric equalization interface, gain can be set under the graphic equalization interface, and the Q value and frequency are not adjustable.

APP SOFTWARE INTRODUCTION

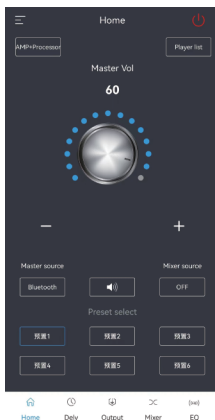

Home Page



Player

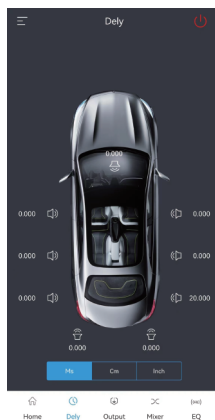

Dely

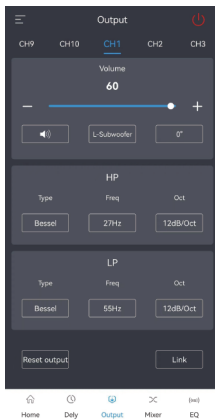

Output

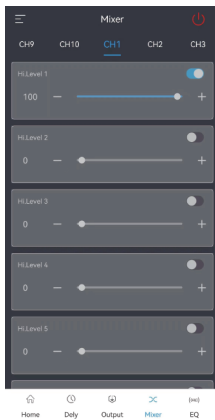

Mixer

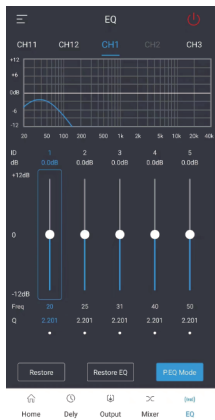

EQ

- Home page: switch between processor and power amplifier + processor mode, switch player page, main volume adjustment, mute, main sound source and auxiliary sound source selection, sound effect recall or storage, main sound source attenuation, view local information and connection operations,
- Player page: You can set the volume, switch songs and other operations,
- Delay page: You can set the delay unit and adjust the delay value,
- Channel page: Set output channel type, reset output channel type, joint tuning, volume, mute, phase, high and low pass type, frequency and slope, etc.
- Mixing page: Mixing settings for each channel,
- EQ page: Adjust the EQ curve of the output channel, adjustable gain, Q value and frequency; reset, pass-through, restore equalization and switch between parametric equalization and graphic equalization,

TROUBLESHOOTING

Before powering on, you should carefully check whether the connection line is normal, and you must ensure that all interfaces are properly connected. Common fault judgment and treatment methods.

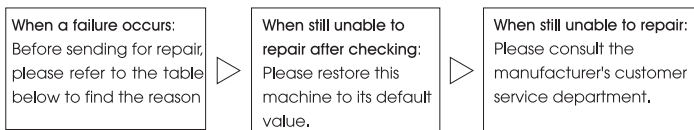

TROUBLESHOOTING METHOD:

Phenomenon	Check The Reason
No power	① Is the power connection properly connected? ② Is the connection method correct?
No sound	① Has the mute operation been activated? ② Is the signal input channel selected correctly?
USB connection is not available	① Is the USB cable inserted in place? ② Is there any discovery in the ergonomic input device of the computer device manager named "HID-compliant device" equipment.

使用本系統之前

非常感謝您購買Onkyo音訊處理器。在使用之前，請詳細閱讀本使用手冊。遵照本使用手冊的指示和說明進行操作，將使您通過新購置的音訊處理器，得到最佳的音響效果和聽覺享受。請妥善保管本使用手冊，以備將來參考。

- 為了防止電氣短路，請勿將設備置於有雨或潮濕的地方。
- 請注意不要讓水或其它液體濺入本設備。如果有水濺入本設備，本設備有可能受到損壞
- 如遇水和其他液體進入設備內，應立即切斷電源，並請專業維修人員檢查維修，以免發生意外。
- 如設備發生故障，請勿打開機蓋，請找專業人員打開和維修。
- 在連接本設備之前，請務必先關閉您的電源。若在電源打開的狀況下進行連接，則可能會損壞本系統。
- 請將本設備放置在牢固的水準表面上。若將其放置在斜面上或放置不穩，則不僅會有設備跌落的危險，還會降低其效果。

功能參數

輸入信號:	2路低電平輸入、內置藍牙、U盤音樂播放、同軸/光纖數位輸入、外接線控（可選）、Hi-Res
輸出信號:	10路低電平、8路高電平
輸出信號增益:	增益範圍: 靜音, -59dB到0.0dB
輸出信號等化器:	31段等化器引擎: <ul style="list-style-type: none">• 頻率範圍: 20Hz~40KHz, 解析度1Hz• Q值(斜率或坡度): 0.404~28.852• 增益: -12.0dB~+12.0dB, 解析度0.1dB
輸出信號分頻器:	每路通道配有多階高低通獨立濾波器。 <ul style="list-style-type: none">• 專業濾波類型: 巴特沃斯(Butterworth)、寧克-銳(Linkwitz-Riley)、貝塞爾(Bessel)• 濾波分頻點: 20Hz-40KHz 解析度: 1Hz• 濾波斜率(坡度)設置: 關閉6dB/Oct 至48dB/Oct
輸出相位和延時:	每路通道可進行相位和延時調整, 參數範圍: <ul style="list-style-type: none">• 相位: 同相 0°或反相180°• 延時: 0.000至20毫秒、0至692釐米、0至273英寸
場景操作:	機器可保存6個預置音樂場景。

規格

動態範圍 (RCA 輸入):	≥100dB
信噪比 (RCA 輸入):	≥100dB
總諧波失真:	≤0.05%
頻率回應:	20Hz~40KHz
輸入阻抗:	低電平: 20KΩ; 高電平: 51Ω
輸出阻抗:	低電平: 51Ω
額定功率:	40W×8
峰值功率:	80W×8
信號輸入 (最大):	RCA: 5.5Vpp; 高電平: 28Vpp
信號輸出 (最大):	RCA: 5.5Vpp
使用環境溫度:	-20°C~70°C
電源:	DC 9V~16V
REM 輸入:	高電平啟動 (H1+H1-)、ACC 啟動可選
REM 輸出:	+12V 啟動電壓輸出 (0.2A)
待機功耗:	≤0.1W
產品淨重:	約1.3Kg
產品尺寸:	187 (長) × 175 (寬) × 43 (高) mm
附件:	R-MX100 × 1 中英文使用手冊 × 1 1.5米USB線 × 1 安裝支架 × 4 20cm喇叭線 × 1 安裝螺絲 (PA4×20) × 4 20cm電源線& 安裝螺絲 (PM3×6) × 4 高輸入線 × 1 魔術貼 (85x55mm) × 2

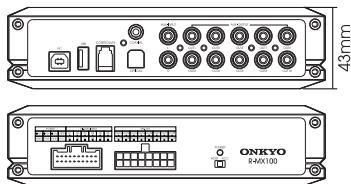
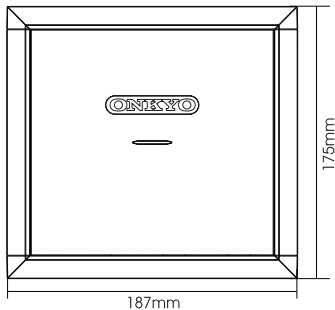

設備埠簡介

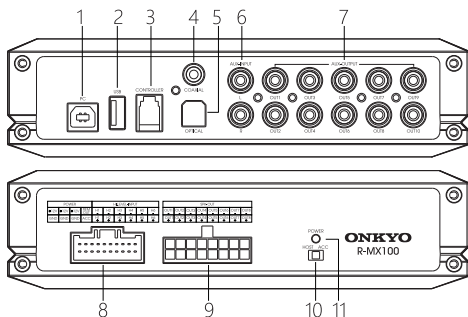

1. USB2.0介面: 連接電腦調音軟體, 免驅動安裝。
2. U盤介面: 可插入U盤, 播放U盤音樂。
3. 線控器介面: 可通過線控器進行資料調用、總音量調節。
4. 同軸輸入埠: 連接車載CD或DVD同軸線, 將機械音源切換至數位, 可播放同軸數位信號。
5. 光纖輸入埠: 連接車載CD或DVD同軸線, 將機械音源切換至數位, 可播放光纖數位信號。
6. 低電平輸入介面: 可插入U盤, 播放U盤音樂。
7. 低電平輸出介面: 最多可接10通道低電平輸出。
8. 高電平輸入及電源介面

POWER				HI.LEVEL-INPUT					
+12V	+12V	+12V	REM OUT	H1 -	H2 -	H3 -	H4 -	H5 -	H6 -
GND	GND	GND	ACC	H1 +	H2 +	H3 +	H4 +	H5 +	H6 +

9. 高電平輸出介面

SPK-OUT							
OUT1 -	OUT2 -	OUT3 -	OUT4 -	OUT5 -	OUT6 -	OUT7 -	OUT8 -
OUT1 +	OUT2 +	OUT3 +	OUT4 +	OUT5 +	OUT6 +	OUT7 +	OUT8 +

10. 機器啟動方式開關: 開關撥至“ACC”端時, 由ACC啟動機器, 撥至“HOST”端時, 由高電平H1+/H1-輸入信號啟動機器。
11. 電源指示燈

PC 控制軟體介紹

電腦配置要求：顯示器解析度大於1280×768，否則不能完全顯示介面。只適應於Windows作業系統的手提電腦、臺式電腦和平板電腦。

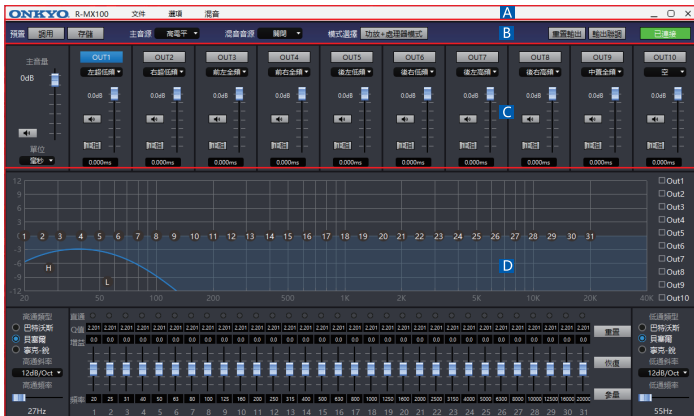

A. 功能編輯區

ONKYO R-MX100 文件 選項 混音

主要功能：檔、選項和混音設置。

- ① 點擊“檔”可載入為電腦場景檔、另存為電腦場景檔、載入為整機檔和保存為整機檔。
- ② 點擊“選項”可切換中英文介面、進入高級項設置主音源衰減比例和雜訊門開關、固件更新、恢復出廠設置和查看版本號等資訊。
- ③ 點擊“混音”進入混音介面，如下圖：

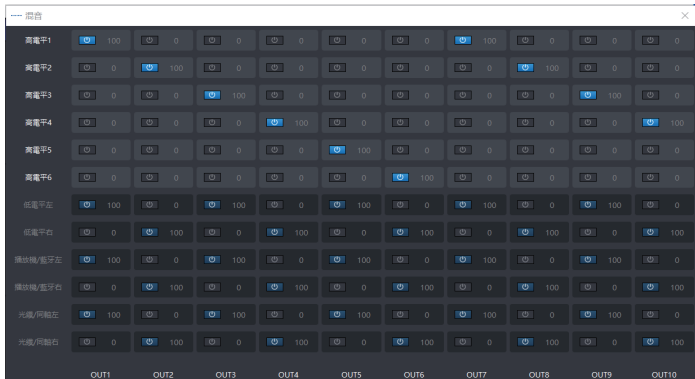

B. 功能編輯區

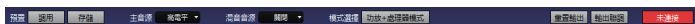

主要功能：預置音效檔調用或存儲、主音源和混音音源選擇、模式選擇、重置輸出類型、輸出聯調和軟體連接。

- ① 點擊“調用”或“存儲”，可調用或存儲6組預置音效資料。
- ② 點擊“主音源”下拉清單選擇輸入音源，有高電平、低電平、播放機和藍牙可選。
- ③ 點擊“混音音源”下拉清單選擇混音音源，有高電平、低電平、藍牙和關閉可選。
- ④ 點擊“功放+處理器模式”可切換為“處理器模式”。
- ⑤ 點擊“重置輸出”可清空當前的通道類型或恢復出廠設置默認通道值。
- ⑥ 點擊“輸出聯調”可選擇聯調同步方式，從左複製到右或從右複製到左。
- ⑦ 點擊“未連接”可連接軟體，點擊“連接”可斷開軟體。

注：需用USB2.0 線連接電腦與機器方可操作！

C. 總音量和輸出配置編輯區



主要功能：

主音量調整和輸出通道的配置、音量調整、靜音、正反相切換和延時設置。

- ① 主音量：可調節範圍：關閉、-59dB~6dB，點擊喇叭可使主音量靜音。
- ② 通道類型：點擊通道類型下拉清單可配置輸出通道類型。
- ③ 通道音量：可調節範圍：關閉、-59.9dB~0.0dB，點擊喇叭可使通道靜音。
- ④ 相位：點擊“正相”可切換“反相”。
- ⑤ 延時：延時單位有毫秒、釐米和英寸可選。

可調節範圍：0.000至20毫秒、0至692釐米、0至273英寸

D. EQ 和濾波器編輯區

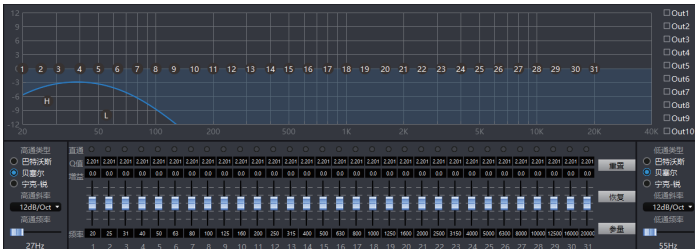

主要功能：通道高低通分配設置、當前輸出通道的EQ設置和等化器設置。

- ① 高低通類型選擇：有巴特沃斯、貝塞爾和寧克-銳可選。
- ② 高低通斜率選擇：有關閉、6dB/Oct、12dB/Oct、18dB/Oct、24dB/Oct、30dB/Oct、36dB/Oct、42dB/Oct 和48dB/Oct可選。
- ③ 高低通頻率可設置範圍：20Hz~40KHz。
- ④ EQ曲線設置：有31段EQ可設置，可拖動相應EQ段設置頻率、Q值和增益。
- ⑤ EQ編輯：可設置增益、Q值和頻率，增益可調範圍：-12dB~-12dB；Q值可調範圍：0.404~28.852；頻率範圍：20Hz~40KHz。
- ⑥ 點擊“重置”可將31段等化器的參數恢復到原廠直通模式（等化器的頻率、Q值和增益都恢復到初始值。）
- ⑦ 當有EQ曲線調節時，點擊“直通”可將所有曲線的增益恢復為0.0，點擊“恢復”可恢復上一次的調節資料。
- ⑧ 點擊“參量”均衡可切換“圖示”均衡介面，參量均衡介面下可設置增益、Q值和頻率，圖示均衡介面下可設置增益，Q值和頻率不可調。

手機軟體使用介紹



主頁

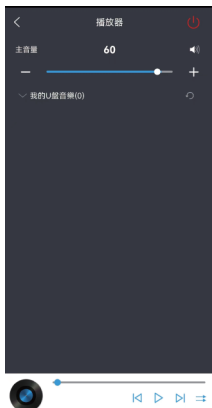

播放機



延時



通道



混音

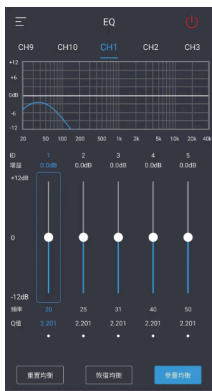

EQ

- ① 主頁頁面：可切換處理器與功放+處理器模式、切換播放機頁面、主音量調節、靜音、主音源和輔助音源選擇、音效調用或存儲、主音源衰減、查看本機資訊和連接操作。
- ② 播放機頁面：可設置音量、切換歌曲等操作。
- ③ 延時頁面：可設置延時單位和調節延時值。
- ④ 通道頁面：設置輸出通道的類型、重置輸出通道類型、聯調、音量、靜音、相位和高低通的類型、頻率和斜率等操作。
- ⑤ 混音頁面：各通道混音設置。
- ⑥ EQ 頁面：對輸出通道EQ 曲線的調節，可調增益、Q 值和頻率；可重置、直通、恢復均衡和參量均衡與圖示均衡切換。

常見故障解決

通電前，應仔細檢查連接線是否正常，必須保證所有介面為正常連接。常見故障判斷及處理方法：

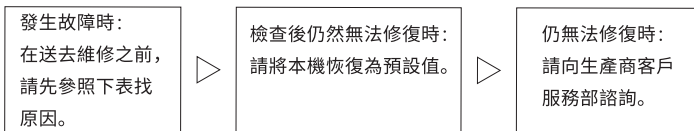

故障排除方法：

故障現象	檢查原因
不通電	<ol style="list-style-type: none"> ① 電源連接是否正確連接？ ② 動方式是否正確連接？
無聲音	<ol style="list-style-type: none"> ① 是否啟動了靜音操作？ ② 信號輸入通道選擇是否正確？
USB連線不上	<ol style="list-style-type: none"> ① USB 連接線有無插到位？ ② 電腦裝置管理員的人體學輸入裝置內有無發現名為“HID-compliant device”的設備。

產品中有害物質的名稱及含量

部件名稱	有害物質或元素					
	鉛 Pb	汞 Hg	鎘 Cd	六價鉻 Cr (VI)	多溴聯苯 PBB	多溴二苯醚 PBDE
電路板元件	×	○	○	○	○	○
殼體組件	○	○	○	○	○	○
配件	×	○	○	○	○	○

本表格依據SJ/T 11364的規定編制

O:表示該有害物質在該部件所有均質材料中的含量均在GB/T 26572規定的限量要求以下。

×:表示該有害物質至少在該部件的某一均質材料中的含量超出GB/T 26572規定的限量要求。



此標誌適用於在中國銷售的電子電氣產品，SJ / T11364《電子電氣產品有害物質限制使用標識要求》，表示該產品在使用完結後可再利用。數位表示的是環境保護使用期限，只要遵守與本產品有關的安全和使用上的注意事項，從製造日算起在數位所表示的年限內，產品不會產生環境污染和對人體，財產的影響。

產品適當使用後報廢的方法請遵從電子電氣產品的回收，再利用相關法令。詳細請諮詢各級政府主管部門。

調音軟體下載方式

1. 網頁地址：<http://onkyocaraudio.cn/app>
2. 掃有右邊二維碼獲取調音軟體下載位址

TUNING SOFTWARE DOWNLOAD METHOD

1. Web page address: <http://onkyocaraudio.cn/app>
2. Scan the QR code below to get the download address of the tunong software.



掃碼獲調音軟體下載位址

ONKYO[®]